

ADD Table System



Features:

With a light design and extreme character, ADD Table System meets the needs of any environment.

Options:

- Tops: Square and rectangle
- Table or conference table
- Conference table available with a central support for cabling
- Cable Management
- Modesty Panels
- Partition Panels
- Bracket for 90° configuration

Design: FRANCESCO ROTA for LAPALMA

Warranty: 5 years

Certifications: FSC

Finishes:

Table tops: HPL Fenix or timber

Powder coat base & bracket: Black or white

Modesty panel: HPL Fenix

Partition panel: HPL Fenix or timber

HPL Fenix:



Black



White



Rosso
Jaipur



Grigio
Londra

Timber:



Blanché
Oak



Black
Open pore

Dimensions

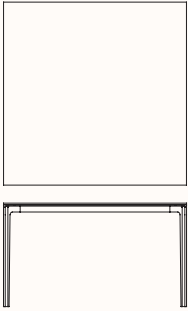

Square

OW 1300/1600/1800mm
 OD 1300/1600/1800mm
 OH 740mm

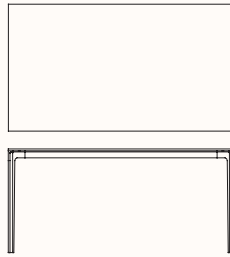

Rectangle

OW 1600/1800/2000mm
 OD 800/900mm
 OH 740mm

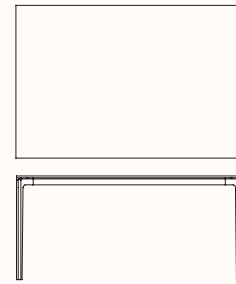

Rectangle

OW 2500/3000mm
 OD 1100mm
 OH 740mm

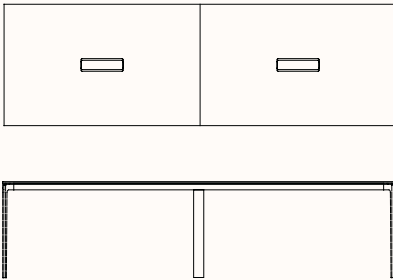

Conference

OW 3200/3600/4200mm
 OD 1300/1500mm
 OH 740mm

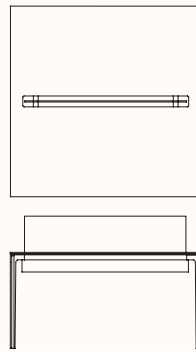

Square with Partitional Panel and Metal Tray

OW 1600mm (Top)
 1140mm (Panel)
 OD 1600mm
 TH 740mm
 OH 1040mm

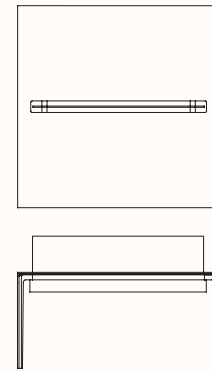

Square with Partitional Panel and Metal Tray

OW 1800mm (Top)
 1360mm (Panel)
 OD 1800mm
 TH 740mm
 OH 1040mm



Corner Leg

OH 730mm



Linking Leg

OH 730mm

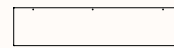

Modesty Panel

OW 1340/1560mm
 OH 350mm



Bracket for 90° Configuration

OW 180mm
 OD 40mm
 OH 50mm

Configurations

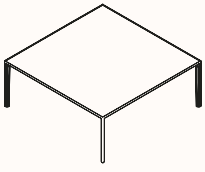

Square

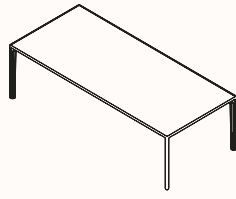

Rectangle

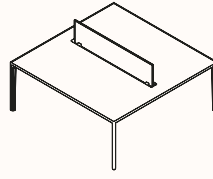

Privacy Screen

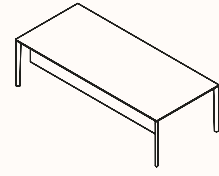

Modesty Screen

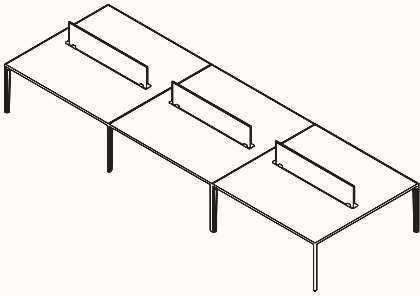

Linked

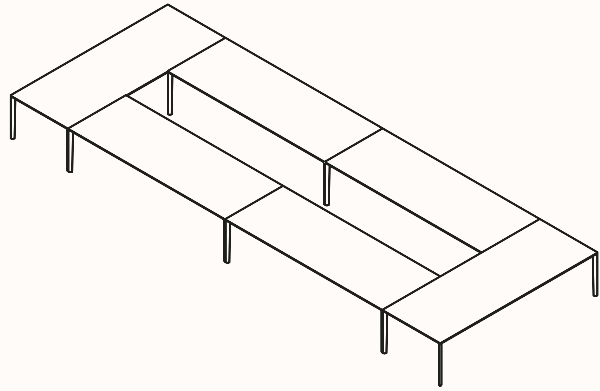

Rectangular Conference

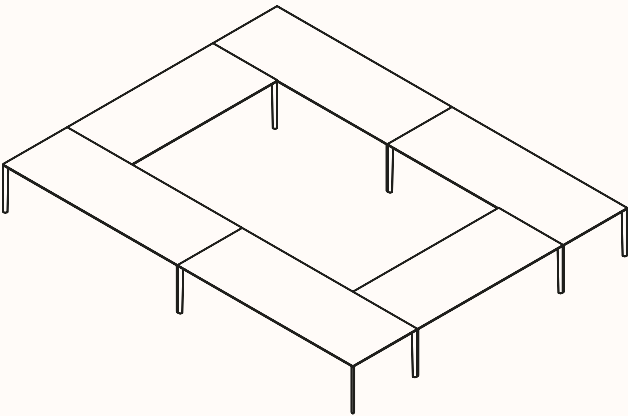

Square Conference